

LED VANITY FIXTURE INSTRUCTIONS

CAUTION

TURN OFF THE MAIN POWER AT THE CIRCUIT BREAKER BEFORE INSTALLING THE FIXTURE, IN ORDER TO PREVENT POSSIBLE SHOCK.



GENERAL

- All electrical connections must be in accordance with local and National Electrical Code (N.E.C.) standards. If you are unfamiliar with proper electrical wiring connections obtain the services of a qualified electrician.
- Remove the fixture and the mounting package from the box and make sure that no parts are missing by referencing the illustrations on the installation instructions.

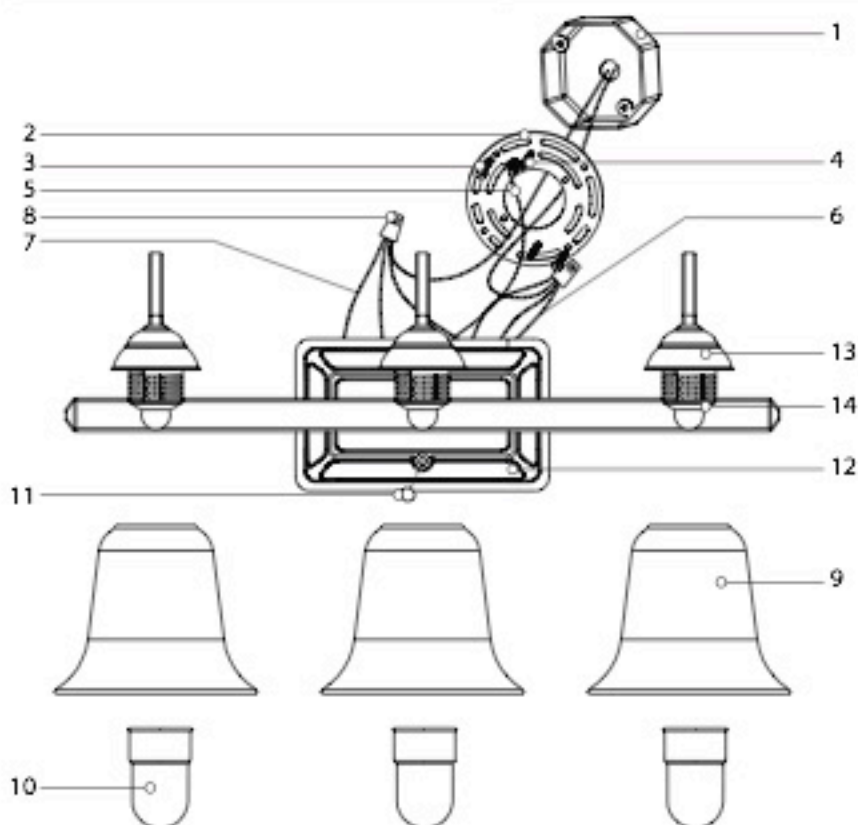

PARTS INCLUDED:



- Outlet Box (not included)
- Mounting Plate (1 piece)
- Outlet Box Mounting Screws (2 pieces)
- Fixture Mounting Screws & Nuts (2 pieces)
- Fixture Ground Wire
- White Fixture Wire
- Black Fixture Wire
- Wire Nut (3 pieces)
- Glass Shade (3 pieces)
- Glass Shade Fastener (3 pieces)
- Finial (2 pieces)
- Fixture Housing (1 piece)
- Glass Holder
- LED Module

MOUNTING INSTRUCTIONS

READ IMPORTANT SAFETY INFORMATION FIRST ON REVERSE SIDE OF THIS SHEET.

- Carefully unpack and unwrap fixture and glass shades.
- Check that black (7), white (6) and ground wire(s) (5) are extending from the back of the fixture. Remove GLASS SHADES (9) if attached to fixture. Before wiring fixture to the power supply, turn off electricity at fuse or circuit breaker box. Fixture must be grounded to avoid potential electrical shock and to ensure reliable lamp starting.
- Insert the FIXTURE MOUNTING SCREWS (4) into the MOUNTING PLATE (2) and secure by tightening included NUTS (4) against the Mounting Plate. NOTE: Make sure MOUNTING SCREWS (2) do not protrude too much or too little from the Mounting Plate. You may need to adjust them to proper length. Once proper length is determined, tighten with nut to secure screws against Mounting Plate.
- Mount Mounting Plate (2) to OUTLET BOX (1) by inserting the two MOUNTING SCREWS (3) through slots in Mounting Plate.
- Lift fixture housing to outlet box. Using wire nuts (8) provided connect green wire (5) from fixture to green or bare copper ground (house) wire. If outlet box is grounded you may fasten fixture ground wire directly to outlet box. Connect white fixture wire(s) (6) to neutral supply wire. Connect black fixture wire(s) (7) to power supply wire.
- Insert FIXTURE MOUNTING SCREWS (4) through fixture housing (12) holes and secure by hand tightening the FINIALS (11) to the ends of the FIXTURE MOUNTING SCREWS (4).

NOTE: Hand tighten finials only. Do not use any tools as overtightening may occur causing damage to fixture housing.

- Slide the GLASS SHADE (9) into the GLASS HOLDER (13) and secure by screwing GLASS SHADE FASTENER (10) onto GLASS HOLDER (13). Repeat step for the remaining GLASS SHADES (9). Hand tighten only.

SAVE THESE INSTRUCTIONS.