

## USE AND CARE GUIDE

---

### 15 IN. WHITE ROUND FLAT PANEL FIXTURE WITH SELECTABLE COLOR TEMPERATURE

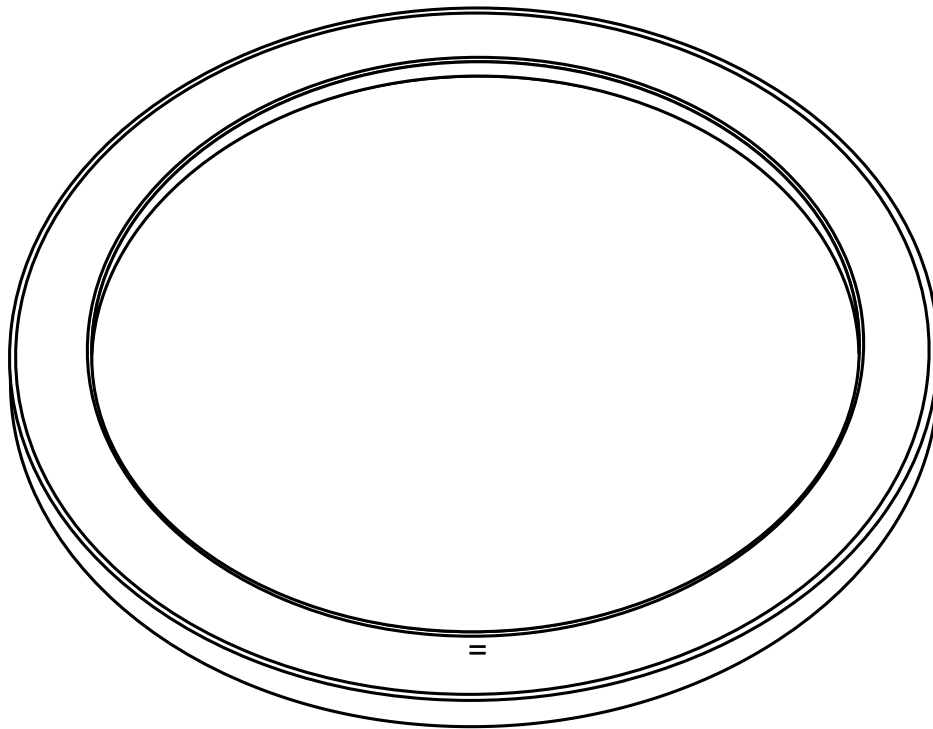

Questions, problems, missing parts? Before returning to the store,  
call Commercial Electric Customer Service  
8 a.m. - 7 p.m., EST, Monday - Friday, 9 a.m. - 6 p.m., EST, Saturday

**1-877-527-0313**

**HOMEDEPOT.COM**

---

#### ***THANK YOU***

We appreciate the trust and confidence you have placed in Commercial Electric through the purchase of this LED Flat Panel Fixture. We strive to continually create quality products designed to enhance your home. Visit us online to see our full line of products available for your home improvement needs. Thank you for choosing Commercial Electric!

# Table of Contents

Table of Contents ..... 2  
Safety Information ..... 2  
Warranty ..... 2  
Pre-Installation ..... 3  
    Tools Required ..... 3  
    Hardware Included ..... 3  
Installation ..... 4-5  
Changing the Color Settings ..... 6

# Safety Information

## For your safety, always remember to:

- Turn off the power supply at the fuse or circuit breaker box before you install the fixture.
- Ground the fixture to avoid potential electric shock and to ensure reliable starting.
- Double-check all connections to be sure they are tight and correct.
- Wear rubber soled shoes and work on a sturdy wooden ladder.
- Account for small parts and destroy packing material, as these may be hazardous to children.

This fixture is designed for use in a circuit protected by a fuse or circuit breaker. It is also designed to be installed in accordance with local electrical codes. If you are unsure about your wiring, check your local electrical code or consult a qualified electrician.

 **WARNING:** RISK OF SHOCK. House electric current can cause painful shock or serious injury unless handled properly.

 **CAUTION:** Turn off the main power at the circuit breaker before installing the fixture, in order to prevent possible shock.

**NOTICE:** All electrical connections must be in accordance with local and National Electrical Code (N.E.C.) standards. If you are unfamiliar with proper electrical wiring connections obtain the services of a qualified electrician.

Remove the fixture and the mounting package from the box and make sure that no parts are missing by referencing the illustrations on the installation instructions.

**Supplier's Declaration of Conformity:**  
47 CFR § 2.1077 Compliance Information  
**Responsible Party:** Feit Electric Company  
4901 Gregg Road, Pico Rivera, CA 90660, USA  
562-463-2852  
**Unique Identifier:** 74212/HD

## FCC STATEMENT

-This device complies with part 15 of the FCC Rules. Operation is subject to the following two conditions:  
(1) This device may not cause harmful interference, and (2) this device must accept any interference received, including interference that may cause undesired operation.  
Note: This equipment has been tested and found to comply with the limits for a Class B digital device, pursuant to part 15 of the FCC Rules. These limits are designed to provide reasonable protection against harmful interference in a residential installation. This equipment generates, uses and can radiate radio frequency energy and, if not installed and used in accordance with the instructions, may cause harmful interference to radio communications. However, there is no guarantee that interference will not occur in a particular installation. If this equipment does cause harmful interference to radio or television reception, which can be determined by turning the equipment off and on, the user is encouraged to try to correct the interference by one or more of the following measures: Reorient or relocate the receiving antenna. Increase the separation between the equipment and receiver. Connect the equipment into an outlet on a circuit different from that to which the receiver is connected. Consult the dealer or an experienced radio/TV technician for help. Any changes or modifications not expressly approved by the manufacturer could void the user's authority to operate the equipment.

# Warranty

This product is warranted to be free from defects in workmanship and materials for up to 5 years from date of purchase. If it fails to do so, please contact the Customer Service Team at 1-877-527-0313 or visit [www.HomeDepot.com](http://www.HomeDepot.com).

# Pre-Installation

## TOOLS REQUIRED

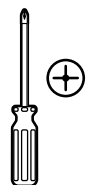

Phillips screwdriver

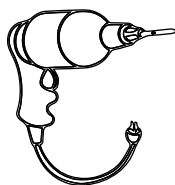

Power Drill



1/8 in. Drill Bit

## HARDWARE INCLUDED

 NOTE: Hardware not shown to actual size.

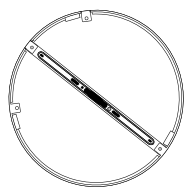

AA

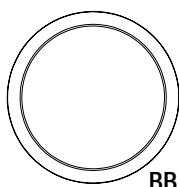

BB



CC

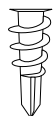

DD



EE



FF

Part	Description	Quantity
AA	Mounting Bracket	1
BB	Lamp Unit	1
CC	#8-32 x 1" Junction Box Screws	2
DD	Plastic Anchors	2
EE	Anchor Screws	2
FF	Wire Nuts	3

# Installation

## 1 Turning Off the Power

- Turn the power OFF at the switch and fusebox or the circuit breaker.

## 2 Removing the fixture from the mounting bracket

- Twist and unlock the mounting bracket (AA) from the round LED flat panel (BB) fixture to remove.

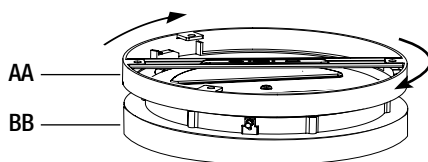

## 3 Identifying the wires

- Identify the wires (Black-line voltage, White-neutral, ground) from the ceiling and make them accessible for easy connections.

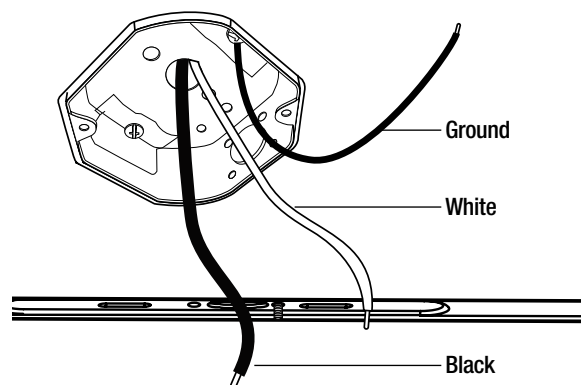

## 4 Attaching the mounting bracket to the junction box in the ceiling

- Secure the bracket (AA) to the junction box using the junction box screws (CC) provided.

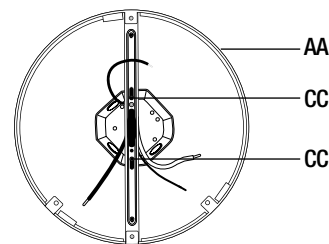

**NOTE:** If securing the bracket with anchors is also desired, follow the remaining steps in step 4. Otherwise, proceed to step 5.

- Use a pencil to mark the two hole positions for the plastic anchors (DD) going in the ceiling.

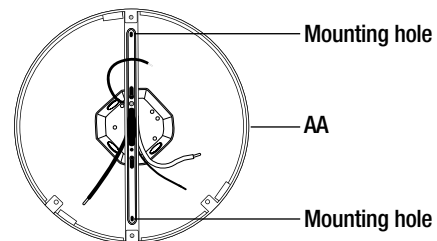

- Remove the bracket (AA) and install plastic anchors (DD) at the marked locations. Use a 1/8 in. drill bit to make a hole and insert a plastic anchor (DD) into each hole by tapping gently.

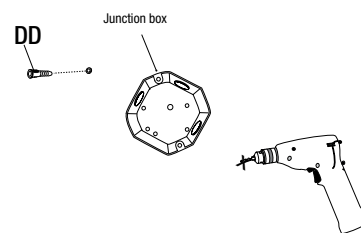

- Screw the mounting bracket (AA) into the Junction box using junction box screw (CC) and into the plastic anchor installed in the ceiling using Anchor screw (EE) until secure.

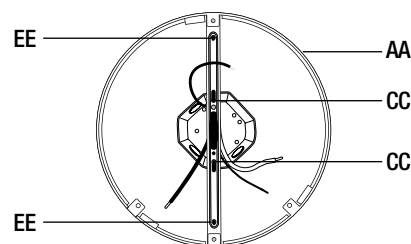

## Installation (continued)

### 5 Connecting the support wire

- Hook the support wire installed in the fixture to the mounting bracket (AA) while you make electrical connections.

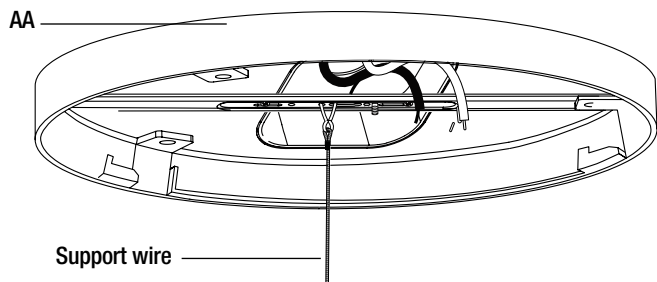

### 6 Connecting the wires

- Feed the lamp unit wires through the mounting bracket (AA) center hole. Use the wire nuts (FF) to connect the 3 wires coming from the junction box as shown (Black-line voltage, White-neutral, ground).

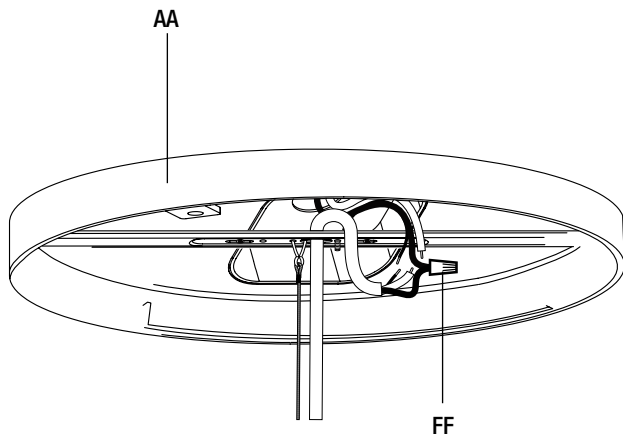

### 7 Attaching the lamp unit to the mounting bracket

- Match up the alignment arrows (1-1) indicated on the mounting bracket (AA) and the lamp unit (BB). Raise the lamp unit into the mounting bracket (AA).

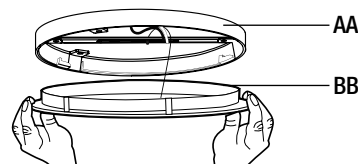

- Twist and lock the lamp unit (BB) into the mounting bracket (AA) in the "Lock direction" position to match up the alignment arrows (1-2).

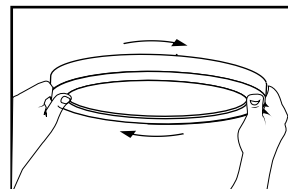
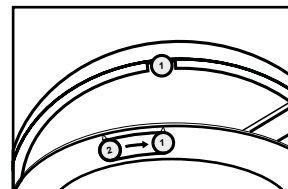

- Once locked in place, remove the stickers and gently align the lamp unit (AA) and mounting bracket (BB) for the best fit.

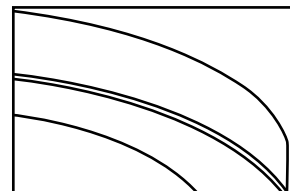

## Color Changing Instructions

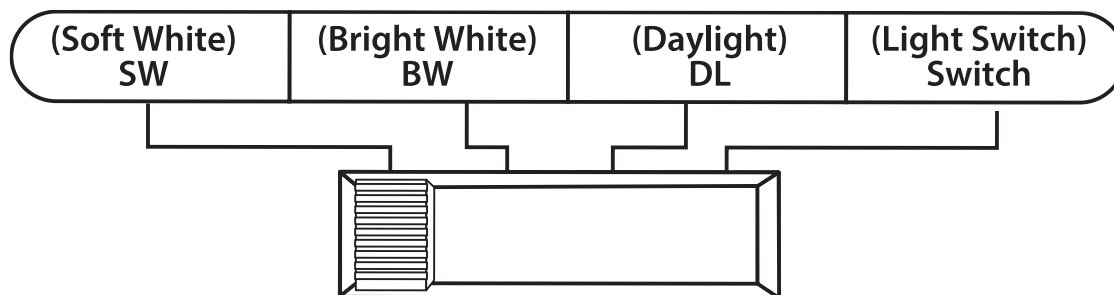

1. You can lock in one color temperature, change among multiple color temperatures, dim from 10%-100%, memorize the last color temperature, and reset automatically.
2. Soft White - Bright White - Daylight - Light Switch  
Marks on the lamp: SW-BW-DL-Switch
3. When the slide switch is set to SW (Soft White), the color temperature is set to 3000K.
4. When the slide switch is set to BW (Bright White), the color temperature is set to 4000K.
5. When the slide switch is set to DL (Daylight), the color temperature is set to 5000K.
6. When the slide switch is set to SWITCH, the color temperature can be changed from SW-BW-DL with your existing light switch.
7. To change color temperatures using your existing light switch:
  - A. Set the slide switch on the back of the fixture to "SWITCH".
  - B. Toggle your light switch ON and OFF within 0.5-3 seconds to cycle through the three different color temperatures.
  - C. The fixture will remember the last color temperature selected after the fixture has been on a selected color temperature for 10 seconds and eventually turned off. To maintain the selected color, do not toggle the switch as detailed in the prior step, but leave off for 10 seconds. The next time the fixture is turned on, the fixture will emit the last color temperature selected.
8. The reset function is used when using multiple Color Selectable lighting products operating from the same light switch. In the event multiple fixtures are not displaying the same color at the same time, fixtures must be RESET using your existing light switch. Simply toggle the wall switch ON and OFF 7 times within 10 seconds. (ex: Fixture in the ON position, toggle the wall switch ON and OFF in about 1 to 1.5 seconds. Repeat 7 times.)



Questions, problems, missing parts? Before returning to the store,  
call Commercial Electric Customer Service  
8 a.m. - 7 p.m., EST, Monday - Friday, 9 a.m. - 6 p.m., EST, Saturday

**1-877-527-0313**

**HOMEDEPOT.COM**

Retain this manual for future use.