

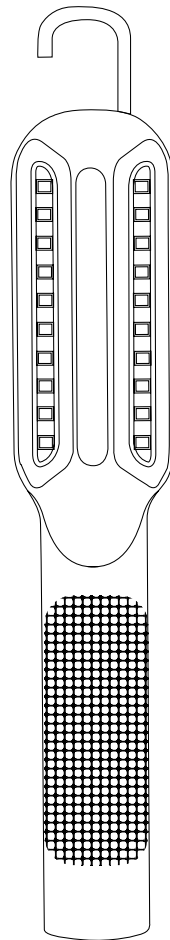

Item # WORK500/1000/BAT

USE AND CARE GUIDE

HANDHELD RECHARGEABLE WORK LIGHT



Questions, problems, missing parts? Before returning to the store,
call Feit Electric Customer Service
8 a.m. - 5 p.m., PST, Monday - Friday

1-866-326-BULB (2852)

FEIT.COM

REV001

THANK YOU

We appreciate the trust and confidence you have placed in Feit Electric through the purchase of this LED Rechargeable Handheld Worklight. We strive to continually create quality products designed to enhance your home. Visit us online to see our full line of products available for your home improvement needs. Thank you for choosing Feit Electric!

Table of Contents

Table of Contents	2
Safety Information	2
Warranty	2
Pre-Assembly	3
Operation	4-5
Care and Cleaning	6

Safety Information

Read and understand all Safety and Operating instructions in this manual before using this product.

Follow all safe guards stated in this manual, in addition to normal safety precautions in working with electrical devices. When using outdoor-use work lights, always follow basic safety precautions to reduce the risk of fire, electric shock and personal injury.

- Use only 3-wire UL listed outdoor extension cords that have 3-prong grounded plugs and grounded receptacles that accept the work light's plug.
- Use only with an extension cord for outdoor use, such as an extension cord of cord type SEW, SEOW, SEOW, SOW, SOOW, STW, STOW, STOOW, SJEW, SJEOW, SJEOW, SJW, SJOW, SJOOW, SJTW, SJTOW, or SJTOOW.
- Ground Fault Circuit Interrupter (GFCI) protection should be provided on the circuit(s) or outlet(s) to be used for wet location tripod work lights. Receptacles are available having the built-in GFCI protection and are able to be used for this measure of safety.
- Do not use with an extension cord near water, or in areas where water may accumulate. Keep the work light at least 16 ft. from pools or spas. Keep plugs dry. Only use this work light with GFCI-protected outlets when in wet locations.
- To disconnect, turn all control to the off (O) position, then remove the plug from outlet. Do not unplug by pulling on cord.
- Do not insert foreign objects into this product.
- To reduce the risk of fire, keep away from combustible materials while in operation.
- To reduce the risk of injury, close supervision is necessary when a product is used near children.



DANGER: BE EXTREMELY CAREFUL WHEN USING THIS DEVICE. Improper use of this work light can result in injury or death.



WARNING: Failure to observe the following safety rules may result in FIRE, ELECTRICAL SHOCK, OR INJURY.



WARNING: Changes or modifications to this unit not expressly approved by the party responsible for compliance could void the user's authority to operate the equipment.



WARNING: These LED lights are extremely bright. Never point toward your eyes or people around you. DO NOT point at moving vehicles or aircraft.

FCC STATEMENT

This device complies with part 15 of the FCC Rules. Operation is subject to the following two conditions: (1) This device may not cause harmful interference, and (2) this device must accept any interference received, including interference that may cause undesired operation. Note: This equipment has been tested and found to comply with the limits for a Class B digital device, pursuant to part 15 of the FCC Rules. These limits are designed to provide reasonable protection against harmful interference in a residential installation. This equipment generates, uses and can radiate radio frequency energy and, if not installed and used in accordance with the instructions, may cause harmful interference to radio communications. However, there is no guarantee that interference will not occur in a particular installation. If this equipment does cause harmful interference to radio or television reception, which can be determined by turning the equipment off and on, the user is encouraged to try to correct the interference by one or more of the following measures: Reorient or relocate the receiving antenna. Increase the separation between the equipment and receiver. Connect the equipment into an outlet on a circuit different from that to which the receiver is connected. Consult the dealer or an experienced radio/TV technician for help. Any changes or modifications not expressly approved by the manufacture could void the user's authority to operate the equipment. Feit Electric Company, 4901 Gregg Road, Pico Rivera, CA 90660. www.feit.com.

Warranty

LIMITED WARRANTY

This product is warranted to be free from defects in workmanship and materials for up to 5 years from date of purchase. If it fails to do so, please contact the Customer Service Team at 1-866-326-BULB (2852) or visit www.Feit.com

Pre-Assembly

SPECIFICATIONS

PRODUCT

Product Weight	01.81 lbs
Product Width	2.34 in.
Product Depth	1.68 in.
Product Height	11.99 in.

LIGHT

Rated Power	Max 5w/10w
Output	500 lm/1000lm
Color Temperature	6500 k
CRI	80 CRI
LED life	> 50,000 hours



NOTE: The brightness will be affected by the battery status.

RECHARGING

Battery	Li-ion 3.7V 2200 mAh
Charger Output	DC 5V 1A
Charging Time	6-7 hours
Charging Indicator	Red - Charging Green - Full Charge
Battery Life	High (100 lm): 3 hours Low (500 lm): 6 hours
Life	Rechargeable up to 500 times

PACKAGE CONTENTS



NOTE: Hardware not shown to actual size.

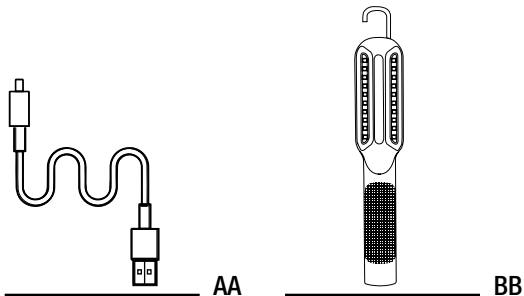

Part	Description	Quantity
AA	USB charging cable	1
BB	Work light	1

Operation

1 Adjusting the stand and lamp

TO ADJUST THE STAND

- Loosen the knobs on both sides of the work light (BB) by turning them counterclockwise. Rotate the two brackets together and separate them in the desired direction. Tighten the knobs by turning them clockwise.

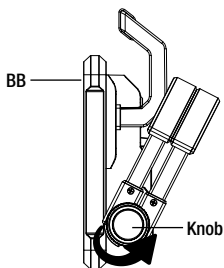

Bracket

Knob

TO ADJUST THE LAMP

- Loosen the knobs on both sides of the work light (BB) by turning them counterclockwise. Hold the lamp handle and move it forward or backward to the desired position. Tighten the knobs by turning them clockwise.

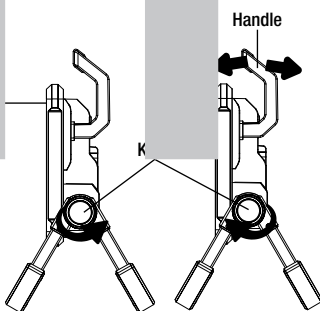

Handle

2 Turning the lamp head on



NOTE: Before using, plug the work light into a power outlet to charge.



NOTE: As long as the work light's battery has a full charge, the work light's lamp and speaker will continue to operate without needing to be plugged into an outlet.

Press the Pairing & Speaker ON/OFF button to turn on the light. Press the Pairing & Speaker ON/OFF button to turn off the light.

Light ON/OFF button

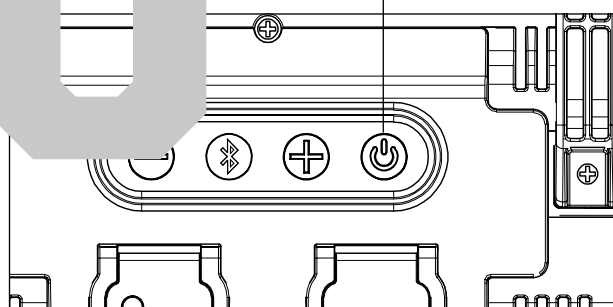

3 Bluetooth pairing

- Press the Pairing & Speaker ON/OFF button to enter Bluetooth mode.
- Press and hold the Pairing & Speaker ON/OFF button for 3 seconds until a Bluetooth activation tone is heard. The work light's Bluetooth mode is now turned on.
- Turn on the Bluetooth feature of a phone. Search and connect to "Feit Work Light 001". Press the Pairing & Speaker ON/OFF button again for 3 seconds until a Bluetooth de-activation tone is heard. The work light's Bluetooth mode is now turned off.
- Press the Pairing & Speaker ON/OFF button to play and pause music.

Pairing & Speaker ON/OFF button

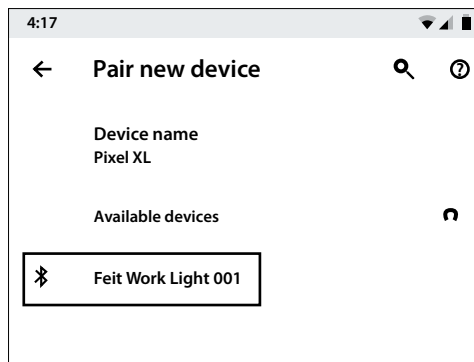
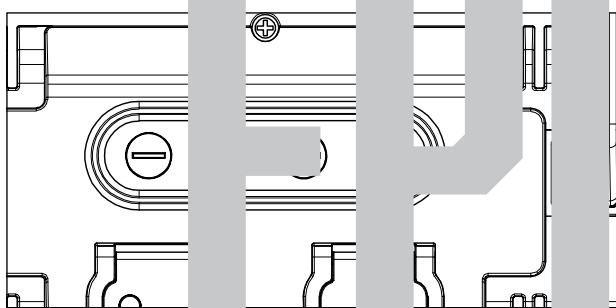

Operation (continued)

4 Volume control and song switching

- Press the Volume Up & Next button once to switch to the next track. Press and hold the Volume Up & Next button to increase the volume level.
- Press the Volume Down & Previous button once to switch to the previous track. Press and hold the Volume Down & Previous button to decrease the volume level.

 **NOTE:** Bluetooth and lamp functions do not need to be used simultaneously. Music will still play audio via the Bluetooth speaker even if the lamp is not turned on.

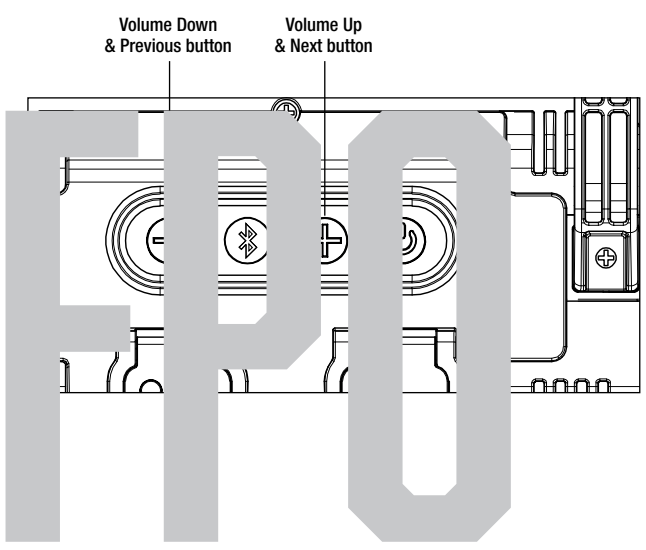

5 Recharging the battery

- Recharge the work light by plugging one end of the DC charging cable kit (AA) into the DC charging port and the other end into a standard 3-prong wall outlet or extension cord.
- When the battery is fully charged, all three charging indicator lights will light up blue. While the battery is charging, the charging indicator lights will blink until the battery is fully charged.
- When not charging, press the power indicator button to display the current battery level. The display will automatically fade away after 10 seconds.

 **IMPORTANT:** Use only 3-wire UL listed outdoor extension cords that have 3-prong grounded plugs and rounded receptacles that accent the plug.

 **NOTE:** Only use the DC charging cable kit (AA) with the work light. A 14V NiMH battery charger will charge the battery. The charging indicator lights will blink while charging.

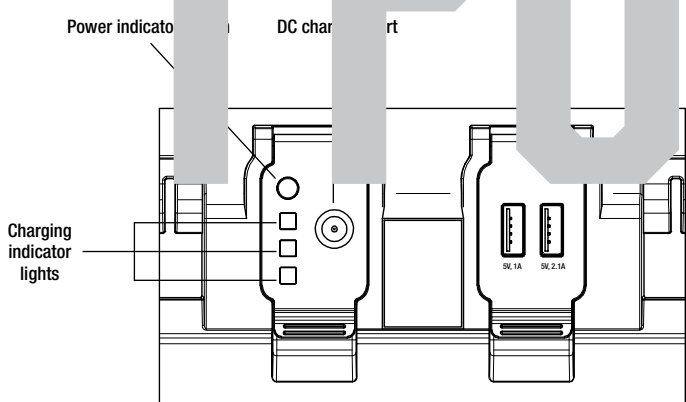

6 Using the USB ports

(USB cables not included)

- The two USB ports can be used to charge two devices simultaneously.
- Plug one end of a USB cable (not included) into one of the work light's USB ports and the other end into a USB-ready device.

 **NOTE:** The USB voltages are DC 5V 2.1A and DC 5V 2.1A. The total current is 4.2A.

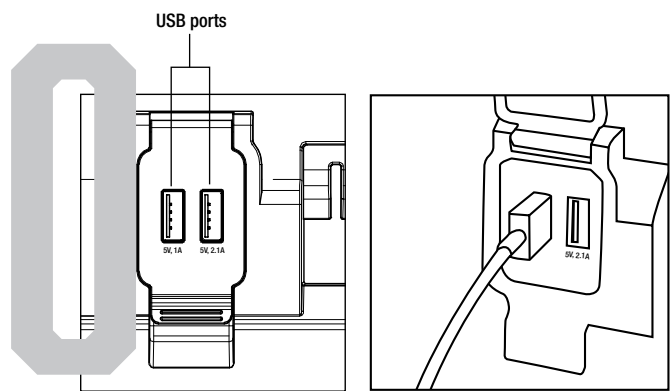

Care and Cleaning

CLEANING THE LAMP

- Clean the lamp head, lens cover and lamp stand regularly with a non-abrasive cleaner.
- Do not use a spray bottle to clean the product
- Allow the work light to cool down completely before storing.
- Store in a safe place, out of the reach of children.
- Do not place or set product where it can potentially fall or be pull into a tub or sink.



WARNING: Always make sure that the product is off, not charging and cooled down before attempting to clean it.

Troubleshooting

If the light does not work, check the following:

- Ensure the fixture is properly plugged into the power source.
- Check to see if the light goes on by pressing the power button.
- The battery may be depleted. Allow the work light to charge for at least 5 hours.



WARNING: If cord/plug or product is damaged or malfunctions in any manner, return the product to the nearest authorized electrical service center for repair or examination.

Servicing of product requires electrical knowledge and should be done by only qualified personnel. Any replacement parts for the product must be identical to those parts in this product.



Questions, problems, missing parts? Before returning to the store,
call Commercial Electric Customer Service
8 a.m. - 5 p.m., PST, Monday - Friday

1-866-326-BULB (2852)

FEIT.COM

SAVE THESE INSTRUCTIONS